



User Manual

HiBoost Hi13-17

HiBoost Consumer Mobile Signal Booster

MADE IN HUAPTEC

Table of Content

Preface	3
Glossary of Terms	3
Safety Warnings	4
Overview	4
Package Contents	5
Features	6
Booster Ports' Description	7
LCD Introduction	7
Control Button Operation and Manual Gain Control (MGC)	9
Installing Hiboost Booster System	10
Before You Install	10
Installation Overview	10
Booster System Installation Examples	10
Step 1. Install the Outdoor Antenna	11
Step 2. Install the Indoor Antenna	14
Step 3. Install the Mobile Signal Booster	15
Step 4. Booster Commissioning	15
Troubleshooting	19
Main Specifications	21
Product Warranty	22
Huaptec Contact Details	22

Preface



This user manual describes design, installation, commissioning and maintenance of Hiboost consumer mobile signal boosters. Please read user manual carefully before installing and maintaining the boosters.

The information in this manual is a subject to change without prior notice. Opinions are welcomed about the manual improvement.

Booster Model

The user manual can be used for the models as below: Hi13-LTE800, Hi13-EGSM, Hi13-DCS, Hi13-3G, Hi13-EW, Hi13-ED, Hi13-3S-IOT, Hi13-3SL-IOT, Hi13-5S-IOT, Hi17-EW, Hi17-3S-IOT, Hi17-3SL-IOT, Hi17-5S-IOT.





Note: The users of repeaters should get permission from the mobile providers for the use and installation of the repeater.

Glossary of Terms

Item	Definition
800MHz	Available on LTE800(832~862MHz/791~821MHz) network
900MHz	Available on EGSM900(880~890MHz/925~935MHz) and PGSM900(890~915MHz/935~960MHz), WCDMA/UMTS900(880~915MHz/925~960MHz) networks
1800MHz	Available on GSM/LTE1800(1710~1785MHz/1805~1880MHz) networks
2100MHz	Available on 3G(WCDMA/UMTS2100) (1920~1980MHz/2110~2170MHz) networks
2600MHz	Available on LTE2600(2500~2570MHz/2620~2690MHz) network
RF	Radio Frequency
ATT	Attenuation
ALC	Automatic Level Control
AGC	Automatic Gain Control
MGC	Manual Gain Control
LNA	Low Noise Amplifier
PA	Power Amplifier
dB	Decibel
dBm	Decibels relative to 1 milliwatt
UL	Uplink
DL	Downlink
Hz	Hertz
MHz	Megahertz
RSSI	Received Signal Strength Indicator
NF	Noise Figure

Safety Warnings

Users must follow the principles stated below:

-  Booster should follow system requirements of mobile signal enhancement equipment, assure good grounding and lightning protection.
-  Booster's power supply voltage should meet the standards of security requirements; any operation should be carried out only after cutting off power in advance. Only the professional is authorized for the operation.
-  Do not dismantle machine, maintain or displace accessories by yourself. In this way the equipment can be damaged and you can even get an electric shock.
-  Do not open the booster, touch the module of booster, or open the cover of module to touch the electronic component. The components will be damaged due to electrostatic.
-  Keep away from heating equipment, because the booster will dissipate heat during working. And do not cover booster with anything that influences heat-dissipation.

Overview

Hiboost consumer boosters are designed to help mobile users to amplify weak cell phone signal.

The devices are bi-directional. The outdoor antenna receives the signal from the cell tower and transmits it to the signal booster, the booster amplifies the signal and the indoor antenna sends it to your mobile device. Visa versa, the signal produced by your phone is also received by the indoor antenna, amplified by the booster and then sent back to the cell tower through the outdoor antenna.

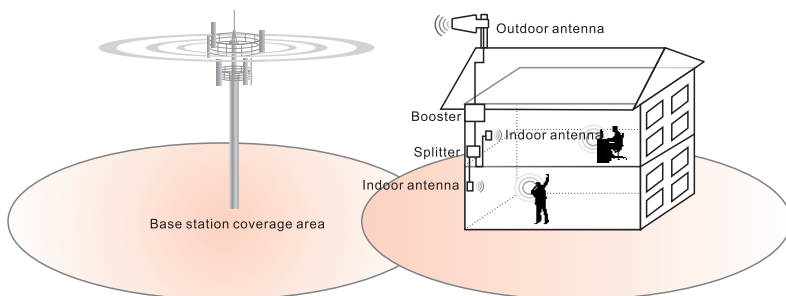

Package Contents

HiBoost Consumer Signal Booster Standard Packing List

No.	Name	Description	Quantity
1	Hiboost Consumer Signal Booster		1
2	Adapter	Hi13 Single Band 5V/3A Hi13-17 Dual Band 12V/3A Hi13-17 Triple Band 12V/3A Hi13-17 Quint Band 12V/3A	1
3	Power Cord	European Standard Plug	5
4	Plastic expansion bolt	Triple Band $\Phi 6$ Quint Band $\Phi 6$	4
5	Tapping screw	Triple Band M4*25 Quint Band M4*25	1
6	User Manual		
7	Outdoor Antenna	N-Female	1
8	Hiboost200 Low-loss Cable	50 feet, N-male	1
9	Whip antenna (only for Hi13 Single/Dual band)	N-Female	1
10	Indoor wide band panel antenna (only for Hi17 Dual band)	N-Female	1
11	Hiboost200 Low-loss Cable (only for Hi17 Dual band)	50 feet, N-male	1

HiBoost Consumer Booster Optional panel kit/omni kit includes the following accessories

No.	Name	Description	Quantity
1	Hiboost200 Low-loss Cable	50 feet, N-male	1
2	Indoor Panel Antenna Indoor Omni Antenna	N-Female	1

Standard Package Contents		Optional Accessories
 Hi13-Single Band	 Hi13-Dual Band	 Panel kit
 Hi17-Dual Band	 Hi13-3/5S-IOT Hi17-3/5S-IOT	 Omni kit

Note: The booster requires outdoor and indoor antennas connected with appropriate RF cables. The length of cable or other accessories needed can vary according to the size and construction materials used in the building, outdoor signal strength and layout of the structure. Please contact us for assistance in designing your system.

If you need to add more indoor antennas or other accessories, please contact Huaptec Support Team on the phone 044-20-32395802 or by e-mail sales1@huaptec.eu.

Features

- Embedded CPU, self-adaptive intelligent system very easy to use and install, better performance is guaranteed even under complicated and constantly changing RF environment conditions.
- ISO: Intelligent isolation processing to avoid self-oscillation, quite wide adjusting range to stabilize the signal strength/quality for clearer voice/ higher data throughput and avoid interference with mobile networks.
- ALC: Intelligent automatic level control, quite wide adjusting range to stabilize the output power and improve the signal quality for clearer voice and higher data throughput.
- LCD Display: Displays ISO status, ALC status, RSSI status, actual gain and downlink output power which makes booster installation and troubleshooting much easier.
- MGC: Control buttons to adjust the gain for both uplink and downlink independently, 31dB range.
- Excellent RF performance, larger coverage area, clearer voice and higher data throughput.
- Elegant design, compact size, very low power consumption to minimize cost during operation and low heat dissipation.
- Built-in indoor antenna

Booster Ports' Description

Single and Dual Band

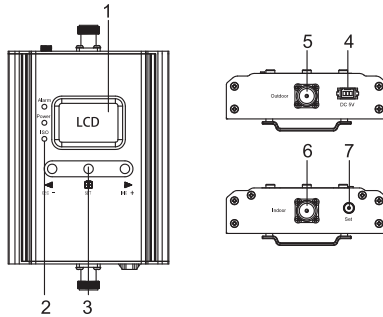

1. LCD 2. LED indicators 3. Control buttons 4. Set
5. Outdoor antenna port 6. Indoor antenna port 7. Power connector

Triple and Quintuple Band

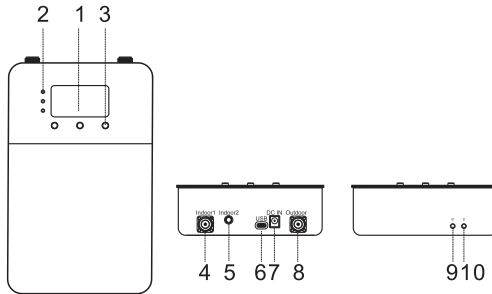

1. LCD 2. LED indicators 3. Control buttons 4. Indoor antenna port 5. Built-in antenna port
6. Set 7. Power connector 8. Outdoor antenna port 9. Wifi led 10. Bluetooth led

If you use this 5 port to connect external indoor antenna, you need order one SMA-M to N-F adapter

LCD Introduction

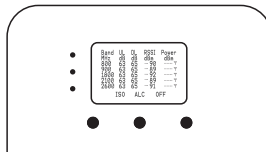

After the booster is on, gain and power will light up on the screen.

“Band”– displays the working frequency. Find below the list of frequencies displayed corresponding to the supported networks.

Frequency	LCD display
LTE800	800 MHz
EGSM&UMTS900	900 MHz
GSM<E1800	1800 MHz
WCDMA/UMTS2100	2100 MHz
LTE2600	2600 MHz

“ULdB”“ DLdB”– gain indication.

The displayed value shows real-time uplink and downlink gain.

“Power dBm”– power indication.

The displayed value shows real-time power. When booster’s output power is lower 40 dBm than rated output power, the value will display “---”.

“ISO”- isolation alarm indication.

When the booster doesn’t have enough isolation between the outdoor and indoor antennas, the “ISO” is flashing. Press the “SET” key and the LCD screen will display “ISO” value showing the current affected band or bands.

Band	UL	DL	RSSI	Power
MHz	dB	dB	dBm	dBm
800	50	50	-40	-17 %att
900	52	57	-42	17 %att
1800	65	70	-47	-1 %att
2100	65	70	-47	-16 %att
2600	65	70	-97	---
ALC				OFF

ISO flash		
Band	UL	DL
800MHz	ISO	ISO
900MHz	---	---
1800MHz	---	---
2100MHz	---	---
2600MHz	---	---

“ALC”- strong receiving power alarm indication.

When the booster’s receiving too strong signal from outside, output power gets overrated and “ALC” starts flashing. Press the “SET” button and the screen will turn on and show the affected band or bands.

Band	UL	DL	RSSI	Power
MHz	dB	dB	dBm	dBm
800	65	50	-40	17 %att
900	52	50	-42	17 %att
1800	50	50	-42	17 %att
2100	65	70	-47	-16 %att
2600	65	70	-97	---
ISO				OFF

ALC flash		
Band	UL	DL
800MHz	---	ALC
900MHz	ALC	ALC
1800MHz	ALC	ALC
2100MHz	---	---
2600MHz	---	---

“OFF”- booster shut-down alarm indication.

When LCD screen is in “OFF” state and the booster shuts down, LCD screen will be flashing.

When LCD screen is “ON” and the booster shuts down, “OFF” is flashing.

Press the "SET" button and the screen will show the affected band or bands.

Band	OFF flash	
	UL	DL
800MHz	---	---
900MHz	---	---
1800MHz	---	---
2100MHz	OFF	OFF
2600MHz	OFF	OFF

Control Button Operation and Manual Gain Control (MGC)

There are 5 operation modes relative to the control keys:

- Press the "SET" key for more than 3 seconds
- Briefly press the "SET" key
- Briefly press the "DEC-" key
- Briefly press the "INC+" key
- Simultaneously press the "DEC-" and "INC+" keys for more than 3 seconds

Since the booster has a self-adaptive smart automatic level control (ALC) and isolation gain processing (ISO), most of the time manual adjustments are not required to achieve good coverage. However, in some cases where the ALC or ISO is working at a very high rate to adjust the gain and the Alarm or ISO LED is flashing more than once a second, a manual adjustment might be required.

When LCD is in the fixed display mode, press the "SET" key for more than 3 seconds. It will go into the "Gain Setting Mode" and make one of the gain values start to blink.

- Press the "SET" key briefly, and the LCD will switch to the next gain value and it will start to blink. (Uplink or downlink gain for a different band).
- Press the "INC+" key once briefly and the gain will increase by 1dB, Press "DEC-" once briefly and the gain value will be reduced by 1dB.
- Press the "SET" key for more than 3 seconds, and the LCD will return to the fixed display mode.

Band	Actual Gain display		MGC Setting Gain		DL	PWR
	UL	DL	UL	DL		
800	60	65	60	63	11	11
900	60	65	60	64	12	12
1800	60	65	60	65	13	13
2100	60	65	60	65	13	13
2600	60	65	60	65	13	13

Actual Power display

Note: When adjusting the gain manually, please ensure that the uplink gain is equal to or not 5 dB less than the downlink gain setting. This avoids interference with the local cell tower network.

When the LCD is in the fixed display mode, press the "DEC-" and "INC+" key simultaneously for more than 3 seconds, the booster will reset the gain to the default manufacturer settings.

When the LCD is in the alarm display mode, press the "SET" key and the LCD screen will turn on to help with troubleshooting and display the alarm indication showing the affected band or bands, press the "INC+" (or "DEC-") key to switch to different pages.

If none of the keys are pushed within 30 seconds, the display will return to the fixed display mode. If none of the control keys are touched within 5 minutes, the LCD screen will turn off. Pressing any key will return the display to the fixed mode.

Installing Hiboost Booster System

Before You Install

- Make sure you have sufficient cable length between the outdoor, indoor antennas and the booster in case you have not a standard kit
- Make sure the place where you install the booster is near to one existing electrical outlet. It should also be well ventilated, away from excessive heat, moisture, and direct sunlight.

Installation Overview

Installation is easy to perform in 4 simple steps:

1. Find the strongest received signal for the location of the outdoor antenna.
2. Install the outdoor antenna on the roof to obtain the strongest downlink signal from the local cellular towers. It should also be as far away as possible from where you plan to place the indoor antenna (vertical separation is more important than horizontal separation).
3. Install the indoor antennas where you want to improve the signal level.
4. Mount the booster, connect the cables from the outdoor antenna and indoor antenna at the designated ports, and connect the booster to the AC supply (make sure all the cables are connected before applying power).

Booster System Installation Examples

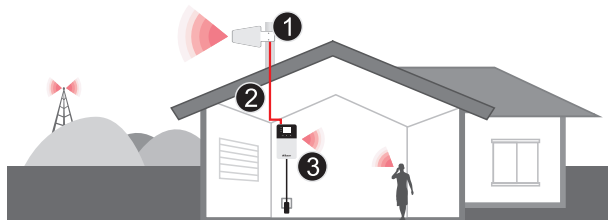

- 1 -Outdoor wide band Directional antenna
- 2 -50ft (15.2m) Hiboost200 low-loss cable
- 3 -HiBoost booster with built-in antenna

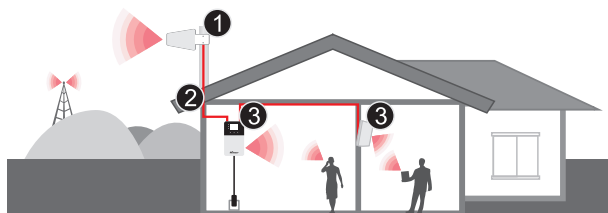

- 1-Outdoor wide band Directional antenna
- 2-50ft (15.2m) Hiboost200 low-loss cable
- 3-You can add an indoor panel/omni antenna and 50ft (15.2 m) Hiboost200 low-loss cable to extend the coverage (built-in antenna will be automatically disabled)

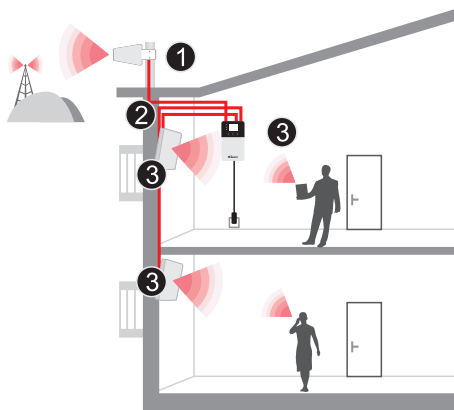

- 1-Outdoor Wide Band Directional Antenna
- 2-50ft (15.2m) Hiboost200 Low-loss Cable
- 3-You can add an indoor panel/omni antenna with the SMA to N connector to connect 50ft (15.2 m) Hiboost200 low-loss cable to extend the coverage (built-in antenna will be automatically disabled)

Step 1. Install the Outdoor Antenna

1.1 How to find the location with the strongest received signal

The booster's main function is to improve a weak RF signal inside a house, office or any other indoor area. The received outdoor downlink signal strength directly affects the efficiency of the indoor coverage. That is why it is crucially important to install the outdoor antenna in a location where signal reception is the

strongest and point it towards the nearest cell tower.

Here are three methods can help find the strongest downlink signal from the local towers:

1. Use the LCD display on the HiBoost amplifier that shows the downlink output power on each band, We highly recommend to use this method as it is generally rather accurate.
2. Use a mobile phone that shows signal bars (the least accurate method).
3. Use a professional signal strength meter. In the situations where the carrier's signal is very weak, using a signal level meter can be the most accurate method of identifying the best signal for installation.

• LCD Display Method

Connect the outdoor antenna to the booster's outdoor port. Fix the outdoor antenna on the roof of the building and point it to the nearest cell tower. Then have a look at the gain and output power values displayed on the LCD display.

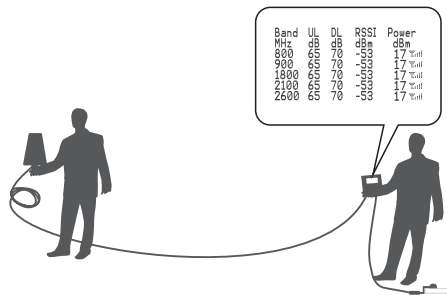

The outdoor antenna receives the strongest signal when the booster's downlink output power reaches its highest level on each band.

The booster's LCD display shows the gain and output power. The output power can be checked below "Power dBm" on the LCD display.

Remark: when ALC shows up flashing, it means the receiving signal power is stronger than the system needs it. It is recommended to change the outdoor antenna position unless ALC alarm disappears. Or you can leave it as it is to let the booster self-adjust automatically. However when ALC is flashing, and the displayed gain is more than 30dB and less than the rated gain value, try to adjust the outdoor antenna to decrease the receiving power.

• Mobile Phone Method

You can use your smart phone to test a signal strength near the window or on the top of the building. A number of bars on the network indicator will define the approximate strength of the received signal. Normally the roof of the building is the best place to receive the strongest signal. As shown on the graph below, you need to test the signal in 5 points from A to E, and select a place with best signal strength for outdoor antenna installation.

It is recommended to use a mobile app that can display a signal level, since it is more accurate than checking signal bars.

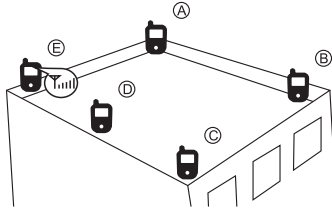

1.2 Install the Outdoor Antenna

Install the outdoor antenna in the location with the strongest received signal.

IMPORTANT: Test the signal 3 times in the desired location before installing the outdoor antenna. It will help ensure the best booster performance.

In most cases, the outdoor wide-band panel antenna is the best choice. You can also choose an outdoor wide band directional antenna as an option.

Pole mounting is recommended for your convenience.

Outdoor Wide Band Directional Antenna Installation:

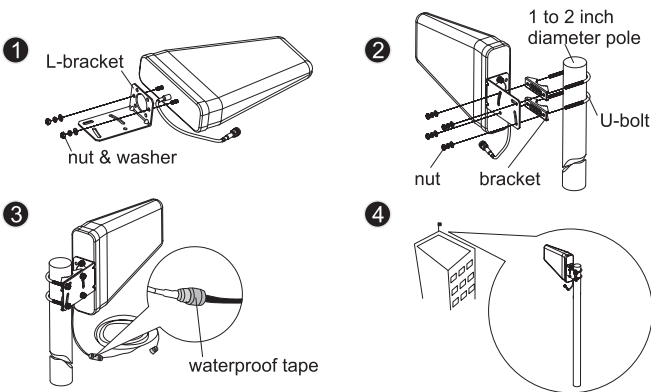

Outdoor Wide Band Panel Antenna Installation:

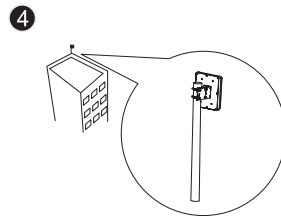
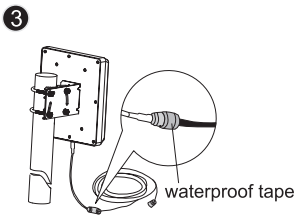
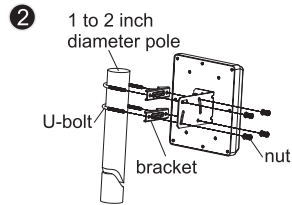
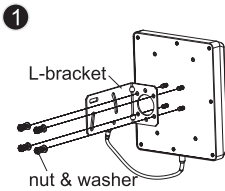

Note: Wrap waterproof tape around the connectors between outdoor antenna and feeder line to avoid water or other kind of damage.

Step 2. Install the Indoor Antenna

If you choose the product's built-in antenna to cover your place, no indoor antenna installation is required.

If you need to extend the booster's coverage area, you can add an external indoor panel antenna. Install the indoor panel antenna as shown on the graph below.

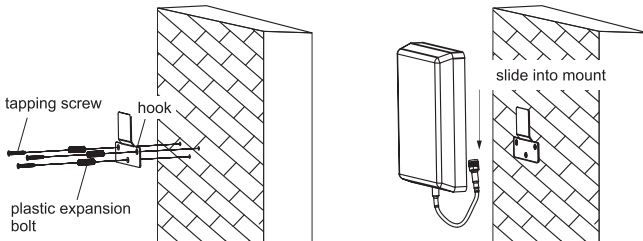

If you have an indoor omni ceiling antenna, the best place to install it is the center of your house.

Install omni ceiling antenna as shown on the graph below.

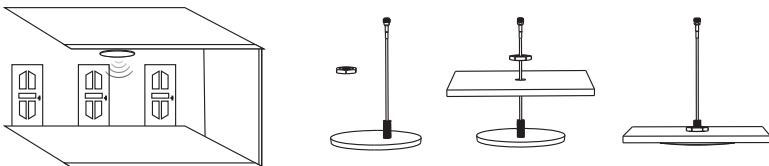

Step 3. Install the Mobile Signal Booster

1. Select the location near a power supply on a wall.
2. Mount the booster with the screws included into the kit as shown on the graph below.

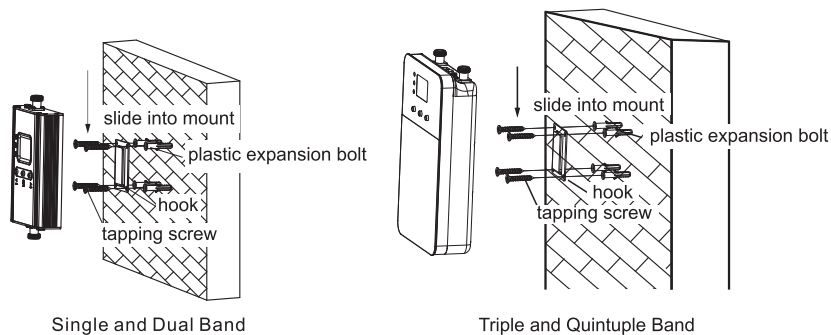

3. Connect the outdoor antenna cable to the booster connector marked as "outdoor". Tighten the connection by hand or with a wrench.
4. Connect the indoor antenna cables to the booster connector marked as "indoor". Tighten the connection by hand or with a wrench.
5. Connect the AC power cord to the signal booster, then connect the plug to the electrical outlet to power on the booster.

Note: If it's necessary to install multiple indoor antennas solution, please contact us, We will provide you with a professional installation plan.

Step 4. Booster Commissioning

The booster has an intelligent startup system, booster commissioning is an automatic process able to guarantee an optimal system performance.

As soon as you finish the booster system installation, plug it into a power supply to start the booster. It will start working and checking the receiving signal strength and the isolation to ensure the best system performance. Automatic adjustment will take about 3-5 seconds.

After the booster starts working, check the coverage. If the signal has improved throughout your home/office, the booster commissioning is completed.

In case the coverage is not enough, please check the following issues.

1. The rated output power is reached, but the coverage is not enough or the signal in some areas has not improved:
 - Check whether the indoor antenna is installed correctly or not, try to change the antenna position to improve coverage.
 - Check if it is necessary to adjust the direction of the indoor antenna.
 - Check whether it is necessary to add more indoor antennas since the

obstructions (thick walls, reinforced fence, natural barriers like hills, mountains, etc.) block the signal.

2. The rated output power is not reached.

- Change the position or direction of the outdoor antenna to get a stronger receiving signal and higher output power (Not necessarily to reach the rated value as long as the coverage is enough).
- Check the LCD display. If the current gain is less than the rated value and "ISO" is flashing, it means the gain is reduced by ISO function for not having enough isolation.

More about "ISO" legend indication

ISO status indicates if the booster has enough isolation between the outdoor and indoor antennas in order to avoid loop back or so-called self-oscillation. HiBoost is equipped with a smart AGC function to avoid interference with mobile networks. "ISO" flashing on the LCD display means that ISO function is working great and self-oscillation has been eliminated.

LCD	Status	Meaning	Solution Methods
ISO status	Remain still	No loop back or no self-oscillation.	No action is needed.
	Flashing but actual gain is not more than 30dB and less than rated gain.	Slight loop back or self-oscillation.	No action is needed.
	Flashing but actual gain is more than 30dB.	Deep loop back or self-oscillation.	Please check the Troubleshooting section to get solutions.

More about "ALC" legend indication

ALC indicates the strength of receiving power of the booster. Flashing ALC means that the booster has strong receiving power.

We Improve Your Mobile Signal

LCD	Status	Meaning	Solution Methods
ALC status	Remain still	Output power is not weak or just suitable.	Check coverage, leave it as it is if it's good. Please check the Troubleshooting section to get solutions if coverage is not good.
	Flashing but current gain is not more than 30 dB and less than rated gain.	Full output power	Working properly.
	Flashing but current gain is more than 30 dB.	Too strong receiving signal.	Working properly, but the signal is too strong. Please check the Troubleshooting section to get solutions.

More about LCD indication:

LCD	Status	Meaning	Solution Methods
"---" status		Output power is lower 40dBm than rated output power.	Check coverage, leave it as it is if it's good; Please check the Troubleshooting section to get solutions if coverage is not good.
"OFF" status	Actual gain is more than 32dB less than rated gain.	Severe loop back or self-oscillation or output power is heavily over rated which leads to booster break down.	Not working properly. Please check the Troubleshooting section to get a solutions.
Flashing LCD screen			

When the ISO or ALC indicators are flashing, please check the ISO and Alarm LED colors.

ISO LED flashing means that ISO function is working well and self-oscillation has been eliminated. ISO LED will remain "Green" or will be "Slow Flashing Green".

Note: This improvement won't increase the coverage, but is mandatory to avoid causing interference to local carrier's cell site towers.

LED	Status	Meaning	Solution Methods
ISO LED	Green	No loop back or no self-oscillation	NO action is needed.
	Slow Flashing Green	Slight loop back or self-oscillation	NO action is needed.
	Quick Flashing Green	Deep loop back or self-oscillation	Not working properly. Check coverage. Leave it as is if it's good. Please check the Troubleshooting section to get a solutions if coverage is not good.
	Quick Flashing Red	Severe loop back or self-oscillation	Not working properly. Please check the Troubleshooting section to get a solutions.
	OFF	The booster auto shuts off for protection due to very severe self-oscillation.	

Alarm LED: Indicates the strength of the received signal from the cell tower. Flashing Alarm means that the booster is receiving a strong signal on one or more bands. Alarm LED shall remain "Green" or "Slow Flashing Green". Slow flashing green indicates that everything is working well and the booster is working at nearly the optimum output power to achieve the best possible coverage.

LED	Status	Meaning	Solution Methods
Alarm LED	Green	Output power is not maximum.	Check coverage, if it is good, leave it as it is; if coverage is not good, increase the receiving signal level.
	Slow Flashing Green	Full output power	Working properly.
	Quick Flashing Green	Output power is too high.	Not working properly. Check coverage, leave it as it is if it's good; actions must be taken if coverage is not good or you don't feel comfortable about Alarm LED quick flashing green.
	Quick Flashing Red	The booster automatically shuts off for protection from excessive downlink signal from tower.	Not working properly, actions must be taken.

Troubleshooting

Problem	Solution
The signal booster has no power.	Check that the AC outlet is working.
The booster's power is on but the phone is not connected to the network and still cannot communicate with the signal.	Try to fasten the connections between the different parts of the system. Change the direction of the donor antenna or its installation position.
Good downlink signal with poor communication quality.	Check whether there's interference. Consult the operator whether the signal source base station works well.
The power is on but the coverage is not good.	Check "ISO", "ALC" or other LCD or LED indications. Take the actions mentioned below.

Eliminate flashing ISO legend and quick flashing green, quick flashing red ISO LED problems:

1. Adjust the outdoor antenna direction, keeping it away from the indoor antenna. Restart the booster.
2. Increase the vertical or horizontal distance between the outdoor antenna and indoor antenna. Restart the booster.

3. Use barriers such as walls to increase the isolation.
4. Change the indoor antenna type to another one with a more directional pattern. Orient the indoor antenna and outdoor antenna so that they point in opposite directions.
5. Reduce the booster's downlink gain using the manual gain control. Keep the uplink gain value and downlink gain value the same, then restart the booster.
Note: Uplink gain must be equal to or not less than 5dB below the downlink gain to avoid interference with the local carrier's network.
Target: The ISO issues are solved when the ISO LED is "Green" or "Slow Flashing Green" or no flashing ISO legend.

Eliminate Flashing ALC legend and Quick Flashing Green, Quick Flashing Red Alarm LED problems:

1. Adjust the antennas' direction or position to lower downlink received signal level.
2. Slowly reduce the downlink gain using the Manual Gain Control.
3. If the above methods don't work, reduce the booster's gain with an external attenuator in line with the outdoor antenna or replace it with a lower gain antenna.

Target: The overload issues are fixed when the Alarm LED is "Green" or "Slow Flashing Green" or no flashing ALC legend. Please note that a "Green" LED indication may result in smaller coverage area. This can be improved by adjusting the outdoor antenna to receive a stronger signal.

Eliminate poor coverage problems when Power "----" legend on LCD and Alarm LED is Green:

1. If the signal has not been improved, please check below:
 - The weak downlink signal leads to the low output signal level. Change the direction or position of the outdoor antenna. You may also try replacing the outdoor antenna with a higher gain antenna to increase the incoming signal.
 - Check if it is necessary to add more indoor antennas. Barriers such as walls can block the signal indoors. You should also check the booster to make sure the power is maximized. Try installing more indoor antennas or replace the booster with one of higher power.
2. If the signal in some part of the house/building hasn't been improved, try the following:
 - Check if the indoor antenna is installed correctly. Try moving the antenna position to improve the coverage.
 - Try adjusting the direction of the indoor antenna.

Remark:

- When increasing the downlink gain make sure the isolation is adequate to prevent system oscillation.

Note: The flashing ISO and Alarm status indicates that ISO and ALC functions are working properly and the problems of self-oscillation and strong downlink

signals are fixed. In most cases, there is no need to take any additional measures except for deep self-oscillation or excessively strong signals from the cell tower. The self-adaptive ALC and isolation gain processing system automatically solve most problems.

Main Specifications

RF Parameter		UL	DL
Frequency Range	900 MHz	880~915 MHz	925~960 MHz
	1800 MHz	1710~1785 MHz	1805~1880 MHz
	2100 MHz	1920~1980 MHz	2110~2170 MHz
	800 MHz	832~862 MHz	791~821 MHz
	2600 MHz	2500~2570 MHz	2620~2690 MHz
Max. Gain			65 dB
Max. output power	Hi13	13dBm	
	Hi17	17dBm	
MGC (Step Attenuation)	ALC	≥31 dB/1 dB step	
Intelligent AGC*	ISO	≥42 dB	
		≥42 dB	
Electrical Parameter			
Power Supply	Single band	Input AC90~264V.50/60Hz, Output DC 5V/3A	
	Dual band	Input AC90~264V.50/60Hz, Output DC 12V/3A	
	Triple&Quint band	Input AC90~264V.50/60Hz, Output DC12V/3A	
Power Consumption	Single band	≤5W	
	Dual band	≤10W	
	Triple&Quint band	≤12W	
Input & Output Impedance		50 ohm	
Mechanical Parameter			
I/O Port Type		N-Female	
Dimensions	Single band	120*155*34mm	
	Dual band	120*198*34mm	
	Triple&Quint band	153*246*36mm	
Weights	Single band	≤0.7 Kg	
	Dual band	≤1 Kg	
	Triple&Quint band	≤1.8 Kg	
Environment Parameter			
Operating Temperature		-10°C~+55°C	
Storage Temperature		-10°C~+80°C	
Relative Humidity		5% - 95%	
Barometric Pressure		55 kPa -106 kPa	
Environment Conditions		IP40	



Product Warranty

60-Day Money Back Guarantee

All Hiboost products are protected by 60-day money back guarantee. If for any reason you're not happy with the performance of the received booster kit, you can return it within 60-day period and get your money back.

2-Year Warranty

Hiboost signal boosters are covered with 2-year warranty. Hupatec offers two options for the products under warranty: repair or replace.

This warranty does not apply to HiBoost signal boosters or kits that have been subjected to misuse, abuse, neglect or mishandling and that have its physical or electronic properties altered or damaged. Failure to use surge protected AC power strip with at least a 1000 Joule rating will void your warranty.

All Hiboost products that are packaged with Hiboost accessory products are intended for use and resale as a single unit, and such product kits are required to be sold to the end users or subsequent reseller as packaged.

For any questions or suggestions do not hesitate to contact Hupatec Support Team on the phone 044-20-32395802 or by e-mail sales1@hupatec.eu.

Hupatec Contact Details

Hupatec CN	Hupatec EU	Hupatec US
Phone/Fax: 086-0755-29921615	Phone/Fax: 44 (20) 3239-5808	Phone/Fax: (972) 870-5666
Address: 5th FL, E BLDG, Sogood Science Park, Hangkong Road, Xixiang, Bao'an, Shenzhen, China 518102	Address: Herderstr. 94, 40721 Hilden, Germany	Address: 6210 N. Belt Line Rd., Ste. 110, Irving, TX, 75063
E-mail: tech@hupatec.com	E-mail: sales@hupatec.eu	E-mail: info@hiboostusa.com
Website: www.hupatec.com	Website: www.hiboost.eu	Website: www.hiboost.com



Address: Herderstr. 94, 40721 Hilden, Germany Phone: +44 (20) 3239-5808
E-mail : sales@huaptec.eu Website : www.hiboost.eu